

### Rental of illuminated and inflatable structures catalog

---

# 2023



<b>easy air system</b>	<b>2</b>
<b>easy columns</b>	<b>15</b>
<b>easy sculptures</b>	<b>16</b>
<b>easy light system</b>	<b>23</b>
<b>easy sails</b>	<b>25</b>
<b>easy sky &amp; truss covers</b>	<b>30</b>
<b>easy cover</b>	<b>30</b>
<b>innolution systems</b>	<b>34</b>

## CATALOGUE 2023 **easy air system**



### Easy air system

Décoration lumineuse composée d'une plateforme technique sur laquelle on fixe une housse. Grâce au ventilateur et l'éclairage à LED, la housse prend forme et s'illumine de l'intérieur.

Support de signalisation et de communication attractif, personnalisable avec impression de logos ou branding complet de la housse.

Fabrication de décorations lumineuses sur mesure, prix sur simple demande.

Système unique d'éclairage RGBW, avec programmes et télécommande, pouvant fonctionner sur batterie. Technologie brevetée.

Luminance propose les structures gonflables lumineuses, et décorations en tissu stretch, en location pour vos événements et animations.

## Design et technologie pour vos événements

### easy air system



#### Plateforme Technique

Eclairage à LED RGBW, équivalent à max. 96W  
Ventilateur avec réglage de puissance  
Télécommande, nombreux effets et programmes  
4 tampons réglables, crochet de suspension  
Usage : Indoor et outdoor IP44  
Diamètre : 60 ou 77cm selon la forme de la housse

Prix de location :  
Plateforme Ø 60cm : CHF 120. - (sans housse)  
Plateforme Ø 77cm : CHF 140. - (sans housse)  
Livraison et reprise non inclus

#### Options :

- Batteries rechargeables d'une autonomie env. 3h par batterie, Maximum 4 batteries /plateforme : CHF 50.-- / batterie louée
- Connexion DMX
- Lestage



#### Exemple d'housse pour plateforme technique

Fixation de la housse au moyen d'une fermeture éclair (zip)  
Couleur blanc (standard)  
Autres couleurs et logo sur demande  
Protection non-feu DIN 4102 B1  
Waterproof, lavable en machine

Le prix de location des housses varie selon le modèle, voir pages 3 à 12 du catalogue.

## CATALOGUE 2023 **easy air system**

### CÔNE



#### CÔNE

CÔNE A1 : Ø 60cm - HA 2.40m  
Prix : CHF 60. --

CÔNE A2 : Ø 60cm - HA 4.50m  
Prix : CHF 80. --

CÔNE A3 : Ø 77cm - HA 6.50m  
Prix : CHF 100. --

Banderoles (vente) :

CÔNE A2 - 50cm : CHF 120. --  
CÔNE A2 - 1.00m : CHF 170. --  
CÔNE A3 - 50cm : CHF 130. --  
CÔNE A3 - 1.00m : CHF 180. --  
Prix dégressif sur la quantité

Branding complet (vente) :

CÔNE A1 : CHF 450. --  
CÔNE A2 : CHF 620. --  
CÔNE A3 : CHF 950. --  
Prix dégressif sur la quantité

#### STARCONE

STARCONE A1 : Ø 77cm - HA 3,50m  
Prix : CHF 85. --

STARCONE A2 : Ø 77cm - HA 4.30m  
Prix : CHF 100. --

#### XMAS CONE

XMAS A1 : Ø 77cm - HA 2.40m  
Prix : CHF 90. --

XMAS CONE A2 : Ø 77cm - HA 5,05m  
Prix : CHF 115. --

## CATALOGUE 2023 **easy air system**

### CUDU



#### CUDU

Ø 77cm - HA 5.00m

Prix : CHF 90. --

Branding complet (vente) : CHF 950. --

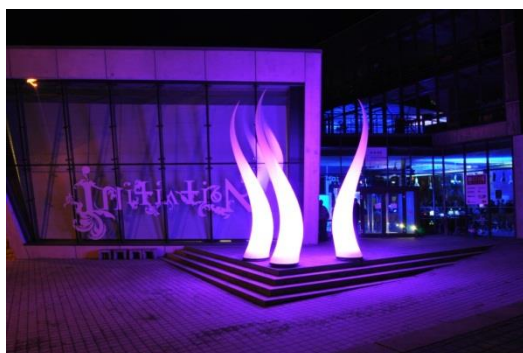

### CUDU FLAME



#### CUDU FLAMME

Ø 77cm - HA 5.00m

Prix : CHF 100. --





## CATALOGUE 2023 **easy air system**

### CURVE



#### CURVE

Ø 77cm - HA 4.50m  
Prix : CHF 90. --

Branding complet (vente) : CHF 930. --



### SWAN & LOOP



#### SWAN & LOOP

SWAN (droite) :  
LA 2.95m - HA 5.20m, base 77cm  
Prix : CHF 120. --



LOOP (gauche) :  
LA 2.95m - HA 3.75m, base 77cm  
Prix : CHF 120. --

## CATALOGUE 2023 **easy air system**

### GLOBE



#### GLOBE

GLOBE A1 : Ø 1.00m  
Prix : CHF 40. --

GLOBE A2 : Ø 1.50m  
Prix : CHF 55. --

GLOBE A3 : Ø 2.00m  
Prix : CHF 70. --

GLOBE A4 : Ø 3.00m  
Prix : CHF 90. --



GLOBE SOCCER A1 : Ø 1.00m  
Prix : CHF 120. --

GLOBE SOCCER A2 : Ø 1.50m  
Prix : CHF 135. --

GLOBE SOCCER A3 : Ø 2.00m  
Prix : CHF 160. --

GLOBE SOCCER A4 : Ø 3.00m  
Prix : CHF 220. --

### DROP



#### DROP

DROP A1 : Ø 0.94m - HA 2.40m  
Prix : CHF 65. --

DROP A2 : Ø 1.28m - HA 4.20m  
Prix : CHF 80. --



## CATALOGUE 2023 **easy air system**

### TUBE



### TUBE

TUBE A1 : Ø 60cm - HA 2.50m

Prix : CHF 70. --

TUBE A2 : Ø 77cm - HA 5.00m

Prix : CHF 85. --

Banderole (vente) :

TUBE A1 - 50cm : CHF 150. --

TUBE A1 - 1.00m : CHF 210. --

TUBE A2 - 50cm : CHF 160. --

TUBE A2 - 1.00m : CHF 240. --

Branding complet (vente) :

TUBE A1 : CHF 580. --

TUBE A2 : CHF 1100. --

Prix dégressif avec la quantité

### SPIKEBALL

HA 4.10m – LA 4.30m, base 77cm

Prix : CHF 110. --

### SPIKEBALL MINI (à suspendre)

HA 2.20m – LA 4.10m, base 60cm

Prix : CHF 85. --

## CATALOGUE 2023 **easy air system**

### NOUVEAUTES 2023



#### **CANDLE**

CANDLE A1 : Ø 60cm - HA 2.40m  
Prix : CHF 75. --

CANDLE A2 : Ø 77cm - HA 5.15m  
Prix : CHF 100. --



#### **RING**

HA 2.95m – LA 2.85m, base 77cm  
Prix : CHF 110. --



#### **KISS**

HA 1.60m – LA 3.70m, base 77cm  
Prix : CHF 110. --



#### **HEART**

HA 3.15m – LA 3.05m, base 77cm

Prix : CHF 115. --



## CATALOGUE 2023 **easy air system**

### FLOWER



#### FLOWER

Divers FLOWERS

Prix : CHF 100. --

Disponible également à la vente, prix sur demande.

Divers MINI FLOWERS

Prix : CHF 90. --

Disponible également à la vente, prix sur demande.

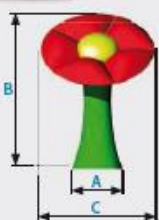

Maß A  
Maß B  
Maß C



FLOWER A1



FLOWER B1



FLOWER C1

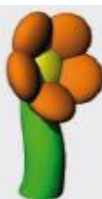

FLOWER D1



FLOWER E1

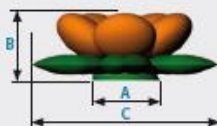

Maß A  
Maß B  
Maß C



MINI FLOWER A1



MINI FLOWER B1



MINI FLOWER C1

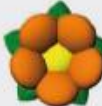

MINI FLOWER D1



MINI FLOWER E1

	Maß A	Maß B	Maß C	Gewicht
FLOWER A1	0,77 m	2,50 m	1,50 m	18,30 kg
FLOWER B1	0,77 m	2,50 m	2,00 m	18,30 kg
FLOWER C1	0,77 m	3,40 m	1,70 m	18,40 kg
FLOWER D1	0,77 m	3,30 m	1,30 m	18,50 kg
FLOWER E1	0,77 m	3,30 m	1,70 m	18,50 kg

	Maß A	Maß B	Maß C	Gewicht
MINI FLOWER A1	0,60 m	1,00 m	2,30 m	15,10 kg
MINI FLOWER B1	0,60 m	1,00 m	2,30 m	15,10 kg
MINI FLOWER C1	0,60 m	1,00 m	2,30 m	15,10 kg
MINI FLOWER D1	0,60 m	1,00 m	2,30 m	15,20 kg
MINI FLOWER E1	0,60 m	1,00 m	2,30 m	15,20 kg

**Farben FLOWER, MINI FLOWER (zur Miete und zum Kauf)\***

A1	B1	C1
D1	E1	

\* Farbiges Rechteck steht für Blütenblätter, farbiger Kreis steht für Blütenmitte. Verfügbarkeit, Lieferzeitraum und Preis von weiteren Blütenfarben auf Anfrage.  
Sonderanfertigungen für easy air system auf Anfrage.  
Licht und Ventilator bei easy air system separat schaltbar.  
Gefertigt in Anlehnung an Schutzart IP 44.

Die Person entspricht im Verhältnis immer einer Größe von 1,85 m.

2013/5

## CATALOGUE 2023 **easy air system**



### **FUNGU**

FUNGU A1 : Ø 77cm – 2.75m - HA 3.05m

Prix : CHF 120. --

FUNGU A2 : Ø 77cm – 2.75m - HA 3.50m

Prix : CHF 140. --

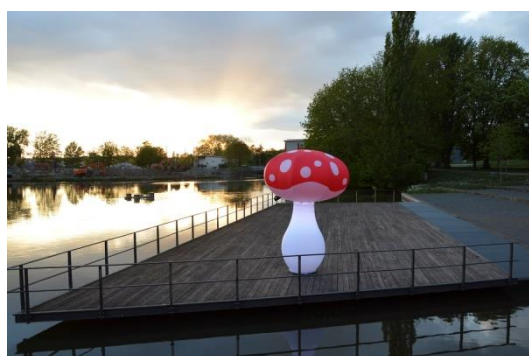

### **FUNGU**

FUNGU B1 : Ø 77cm – 2.75m - HA 2,75m

Prix : CHF 130. --

FUNGU B2 : Ø 77cm – 2.75m - HA 3.20m

Prix : CHF 150. --

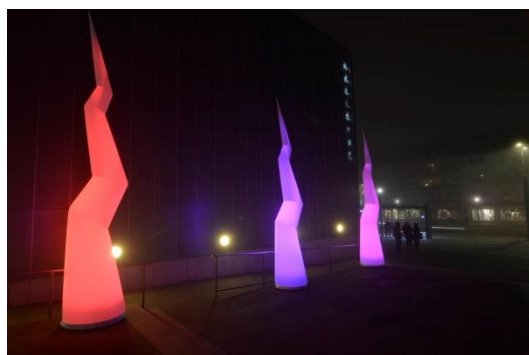

### **FLASH**

FLASH A1 : HA 2.60m – LA 70cm, base 60cm

Prix : CHF 70. --

FLASH A2 : HA 4.75m – LA 80cm, base 77cm

Prix : CHF 90. --



### **CACTUS**

CACTUS : LA 77cm – 2m - HA 3,90m

Prix : CHF 110. --

**CATALOGUE 2023 easy air system**

**GLOBE TENNIS**

GLOBE TENNIS A1 : LA 1.60m - HA 1.50m – Base 60cm  
 Prix : CHF 120. --

GLOBE TENNIS A2 : LA 2.15m - HA 2.05m – Base 77cm  
 Prix : CHF 140. --

**SMILEY**

SMILEY A1 : HA 1.35m – LA 1.25m, base 60cm  
 Prix : CHF 90. --

SMILEY A2 : HA 2.10m – LA 2m, base 77cm  
 Prix : CHF 120. --

**PUMPKIN**

PUMPKIN A1 : HA 2.30m – LA 2m, base 60cm  
 Prix : CHF 120. --

PUMPKIN A2 : HA 2.90m – LA 2.50m, base 77cm  
 Prix : CHF 160. --

**GHOST**

GHOST A1 : HA 3.10m – LA 1.90m, base 60cm  
 Prix : sur demande

GHOST A2 : HA 3.90m – LA 2.4m, base 77cm  
 Prix : sur demande

**CATALOGUE 2023 easy air system****SQUID**

SQUID : Ø 3.80m - HA 2.20m, base 60cm  
Prix : CHF 110. --

**MOON**

MOON: LA 3m - HA 2,25m – Base 77cm  
Prix : CHF 110. --

**BIRD**

BIRD: LA 4.80m - HA 3.95m – Base 77cm  
Prix : CHF 130. --

**HARP**

HARP: LA 3.80m - HA 4m – Base 77cm  
Prix : CHF 130. --



**CATALOGUE 2023 easy air system**



**PEAK**

PEAK A1 : LA 50cm - HA 2.30m

Prix : CHF 150. --

FPEAK A2 : LA 1m - HA 3.50m

Prix : CHF 230. --



**WING**

WING A1 : HA 2.80 – 2m LA 2m – 50cm

Prix : CHF 150. –

WING A2 : HA 2.85 – 1.80m LA 1.20m – 50cm

Prix : CHF 150. –

WING A3 : HA 2.80 – 2m LA 2m – 50cm

Prix : CHF 150. –



**GATE A1**

GATE A1 : LA 6.00m - HA 3.40m

Prix : CHF 165. --

## CATALOGUE 2023 **easy air system**



### **GATE B1**

GATE B1 : LA 6.90m - HA 4.85m  
Prix : CHF 190. --

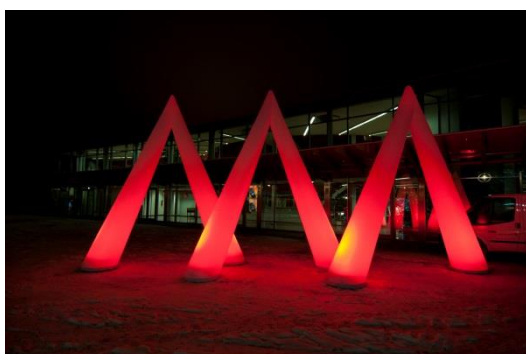

### **GATE C1**

HA 4.95m – LA 4.05m, bases 77cm  
Prix : CHF 160. --



### **GATE D1**

HA 3.90m – LA 5.60m, bases 77cm  
Prix : CHF 190. --



### **GATE E1**

HA 4.50m – LA 5.21m, bases 77cm  
Prix : CHF 195. --

## CATALOGUE 2023 **easy columns**

### BANGKOK

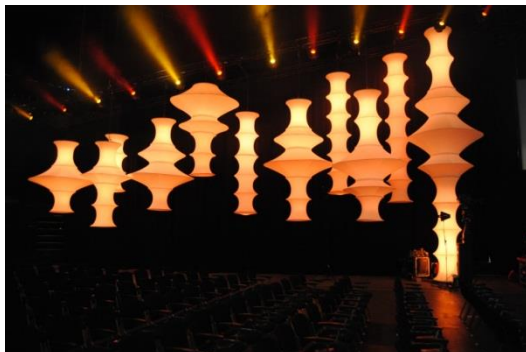

#### BANGKOK

BANGKOK A1 : Ø 77cm - HA 2.50m  
Prix : CHF 120. --

BANGKOK A2 : Ø 77cm - HA 5.00m  
Prix : CHF 150. --

ADAPTER A1 : Ø 77cm - HA 0.80 à 1.20m  
Prix : CHF 60. --

ADAPTER A2 : Ø 77cm - HA 1.70 à 2.30m  
Prix : CHF 90. --

ADAPTER B1 : Ø 77cm - HA 50cm à 70cm  
Prix : CHF 90. --

ADAPTER B2 : Ø 77cm - HA 70cm à 90cm  
Prix : CHF 120. --

Accessoires d'accroche et LED spéciales en option

### HELSINKI

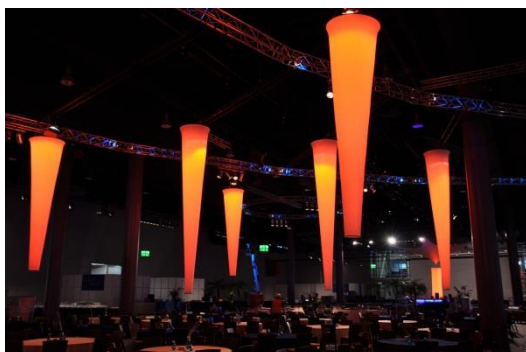

#### HELSINKI

HELSINKI A1 Pointe : Ø 77cm - HA 2.50m  
Prix : CHF 200. --

HELSINKI A2 Pointe : Ø 77cm - HA 5.00m  
Prix : CHF 230. --

HELSINKI A3 Pointe : Ø 77cm - HA 7.50m  
Prix : CHF 260. --

HELSINKI B1 : Ø 40-77cm - HA 2.50m  
Prix : CHF 210. --

HELSINKI B2 : Ø 40-77cm - HA 5.00m  
Prix : CHF 240. --

HELSINKI B3 : Ø 40-77cm - HA 7.50m  
Prix : CHF 270. --

HELSINKI C1 : Ø 77-77cm - HA 2.50m  
Prix : CHF 230. --

HELSINKI C2 : Ø 77-77cm - HA 5.00m  
Prix : CHF 260. --

HELSINKI C3 : Ø 77-77cm - HA 7.50m  
Prix : CHF 290. --

Accessoires d'accroche et LED spéciales en option



## CATALOGUE 2023 **easy columns**

### SANSIBAR



#### SANSIBAR

Ø 4.00m - 0.40m - HA 5.50 à 6.00m

Prix : CHF 1100. --

Disques d'embase inclus



#### DONUT

DONUT A1 (suspension) : Ø 3m - 1m - HA 50cm  
Prix : CHF 4200. --

DONUT A2 (suspension) : Ø 3m - 1m - HA 1m  
Prix : CHF 580. --

DONUT A2 (à poser au sol) : Ø 3m - 1m - HA 1m  
Prix : CHF 580. --

Eclairage avec 4 spot Accu : CHF 250, --



## CATALOGUE 2023 **easy columns**

### TURIN

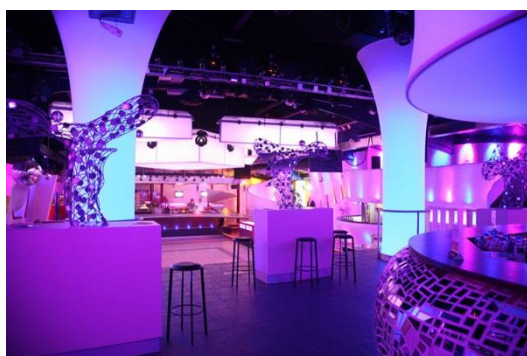

### TURIN

TURIN A1 : Ø Sommet 4.00m – Base 1.20m - HA 5.50m à 6m  
Prix : CHF 850. --

TURIN A2 : Ø Sommet 6.00m – Base 2.00m - HA 5.50m à 6m  
Prix : CHF 1450. --

### ZÜRICH



### ZÜRICH

ZÜRICH A1 : Ø Sommet 4.00m – Base 4.00m - HA 8.50m  
Prix : CHF 1350. --

ZÜRICH A2 : Ø Sommet 6.00m – Base 6.00m - HA 8.50m  
Prix : CHF 1900. --

## CATALOGUE 2023 **easy sculptures**

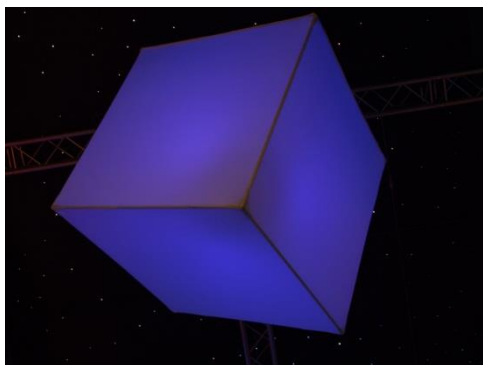

### **CUBE**

CUBE : 1m3, poids 2.40kg

Prix :  
Blanc : CHF 120. --  
Avec Space Light : CHF 190. --

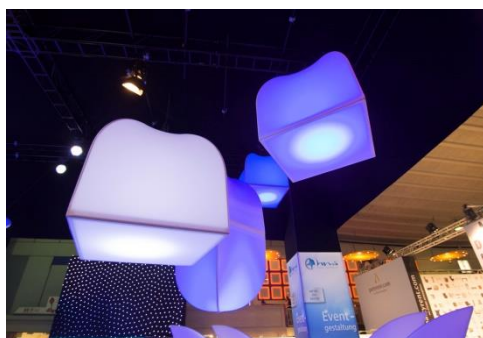

### **POTTY**

POTTY : Dimensions : 1m x H1m

Prix :  
Blanc : CHF 110. --  
Avec 1x Spot LED accu : CHF 170. --

POTTY Double : Dimensions : 1m x H2m

Prix :  
Blanc : CHF 210. --  
Avec 1x Spot LED accu : CHF 270. --

### **CURL**



### **CURL**

CURL A1 : Ø 70cm - HA 2.50m

Prix :  
Blanc : CHF 65. --

CURL A2 : Ø 70cm - HA 5.00m

Prix :  
Blanc : CHF 95. --

Options :  
Fixation de plafond et sol  
Eclairage

## CATALOGUE 2023 **easy sculptures**

### DISK



### DISK

DISK A1 : Ø 2.00m : CHF 160. --  
DISK A2 : Ø 4.00m : CHF 360. --  
DISK A3 : Ø 6.00m : CHF 650. --

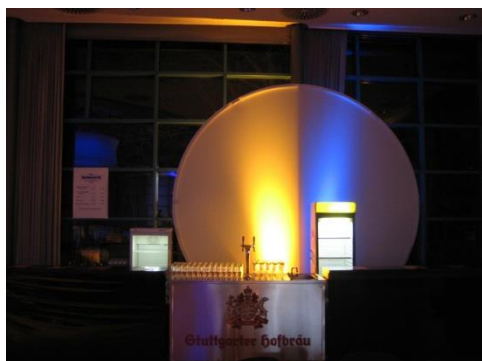

### DISK 3D



### DISK 3D

DISK 3D A1 : Ø 4.00m - PR 1.00m

Prix : CHF 630. --  
Avec LED : CHF 850. --

DISK 3D A2 : Ø 6.00m - PR 1.00m

Prix : CHF 1100. --  
Avec LED : CHF 1400. --



## CATALOGUE 2023 **easy sculptures**

### PINE

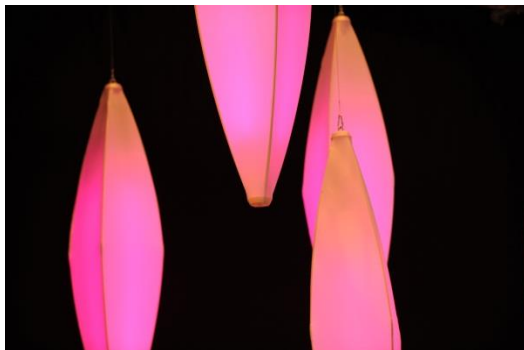

#### PINE

PINE A1 : Ø 50cm – HA 2.20cm, poids 2.00kg

Prix :  
Blanc : CHF 120. --  
Avec Space Light : CHF 190. --

PINE A2 : Ø 60cm – HA 3.60cm, poids 3.90kg

Prix :  
Blanc : CHF 155. --  
Avec Space Light : CHF 190. --

Pied de 18kg : CHF 30. --



### PLANET



#### PLANET

PLANET A1 : Ø 80cm, poids 1.30kg

Prix :  
Blanc : CHF 70. --

PLANET A2 : Ø 1.15m, poids 3.00kg

Prix :  
Blanc : CHF 120. --  
Avec Space Light : CHF 190. --

PLANET A3 : Ø 1.50m, poids 4.00kg

Prix :  
Blanc : CHF 160. --  
Avec Space Light : CHF 230. --

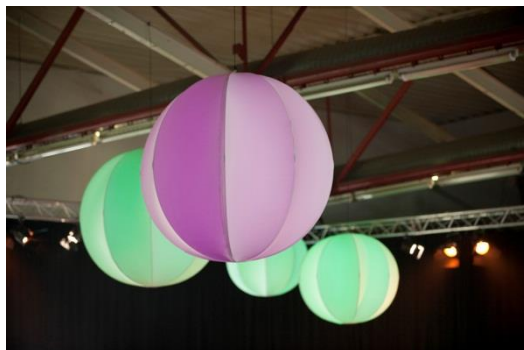



## CATALOGUE 2023 **easy sculptures**



### **RINGSTAR**

RINGSTAR A1 : LA 2m – PR 50cm, poids 9kg

Prix : CHF 180. --

RINGSTAR B1 : LA 3m – PR 75cm, poids 14kg

Prix : CHF 250. --

RINGSTAR C1 : LA 4m – PR 1m, poids 18.5kg

Prix : CHF 320. --

Fourni avec support de suspension

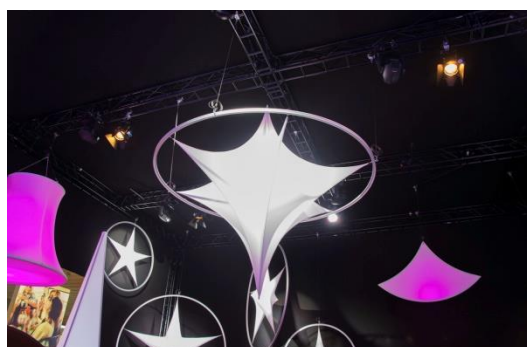

### **TRIAS**

TRIAS A1 : LA 2,50m – PR 50cm, poids 26kg

Prix : CHF 210. --

TRIAS A2: LA 2,50m – PR 1m, poids 31,2kg

Prix : CHF 250. --

TRIAS A3 : LA 2,50m – PR 1,50m, poids 34,4kg

Prix : CHF 270. --

TRIAS A4 : LA 2,50m – PR 2m, poids 38,6kg

Prix : CHF 320. --

Fourni avec support de suspension

## CATALOGUE 2023 **easy sculptures**



### STAR

STAR A1 : LA 80cm – PR 20cm, poids 0.50kg

Prix :  
Blanc : CHF 45. --

STAR A2 : LA 1.50m – PR 40cm, poids 0.90kg

Prix :  
Blanc : CHF 75. --

STAR A3 : LA 2.00m – PR 60cm, poids 1.20kg

Prix :  
Blanc : CHF 85. --

Anneau de fixation

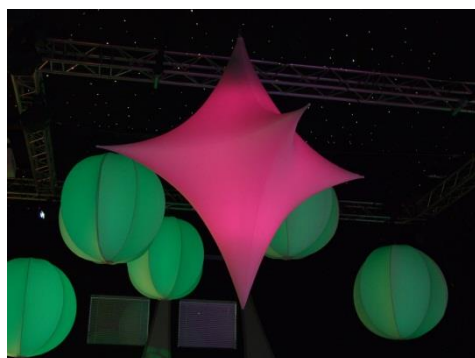
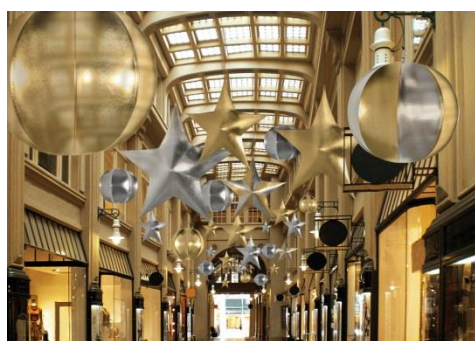

### STAR 3D

STAR 3D : LA 2.00m – PR 2.00m, poids 2.80kg

Prix :  
Blanc : CHF 120. --  
Avec Space Light : CHF 180. --

Anneau de fixation



### BLOB

BLOB : LA 1.10m – HA 1.70m, poids 4kg

Prix :  
Blanc : CHF 120. --  
Avec Space Light : CHF 180. --

Anneau de fixation

## CATALOGUE 2023 **easy light system**

### SPACE LIGHT

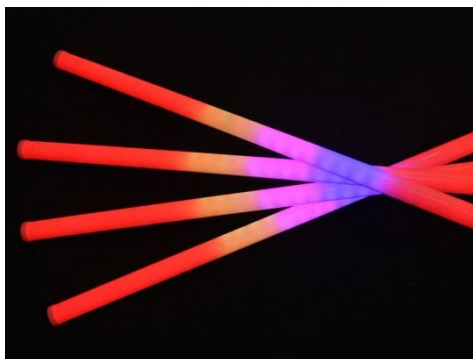
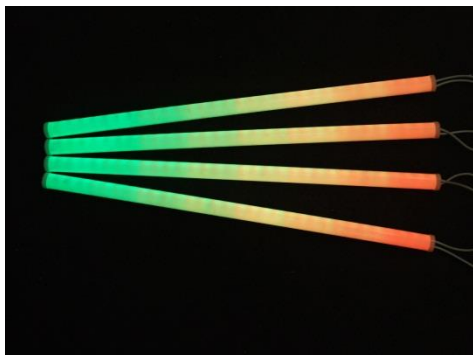

#### SPACE LIGHT

Space Light (4 tubes) : CHF 80. --

RGBW, 16-27W, 120°, DMX

Autonomie :

de 5 heures sur blanc froid à puissance maximale

à 15 heures sur rouge à puissance normale

Charge : 10 heures

Exigences d'alimentation pour le câblage électrique fixe : 250W

Télécommande

Dimensions :

A : 1.05m

B : 0.04m

Space Light HD (8 tubes) : CHF 220. --

Dimensions :

A : 1.00m

B : 0.05m

Télécommande incluse

### LED ACCU SPOT



#### LED ACCU SPOT

LED ACCU SPOT

RGBW, 108W, 25°, DMX

Autonomie :

de 5.6 heures sur blanc froid à puissance maximale

à 21 heures sur rouge à puissance normale

Charge : 8 heures

Exigences d'alimentation pour le câblage électrique fixe : 250W

Télécommande

Dimensions :

A : 0.18m

B : 0.28m

C : 0.17m

Poids : 5.10kg

Prix : CHF 80. --

## CATALOGUE 2023 **easy light system**

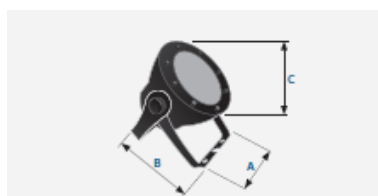
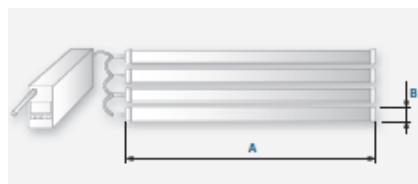

	Size A	Size B	Weight		Size A	Size B	Size C	Weight
SPACE LIGHT	1.05 m	0.04 m	3.90 kg	LED AKKU SPOT	0.18 m	0.28 m	0.17 m	5.10 kg

Specifications		
	SPACE LIGHT	LED AKKU SPOT
LED power	16 -27 watts	108 watts
Beam angle	120 degrees	25 degrees
Resolution	8 pixel/meter	1 pixel
Environment	indoor	indoor & outdoor (IP 44)
LED type	RGBW-LED	RGBW-LED
DMX capable	yes	yes
DMX input/output	Wireless DMX transmitter	DMX-input/output Wireless DMX transmitter
Usage areas	Under table lighting, Effect lighting, Furniture lighting, Event lighting	Under table lighting, Effect lighting, Furniture lighting, Objet lighting, Event lighting
Battery durations for white cold – Normal Brightness (100%)	8 h	8 h
Battery durations for Red – Normal Brightness (100%)	15 h	21 h
Battery durations for white cold – High Brightness (120%)	5 h	5,6 h
Battery durations for Red – High Brightness (120%)	8 h	15,7 h
Charging times	10 h	8 h
Electricity required for power cable	max. 250 watts	max. 75 watts

Control options		
	SPACE LIGHT	LED AKKU SPOT
Remote control: control is either synchronous or in different groups	x	x
DMX: connection to a lighting console via 3-pole XLV cable		x
Wireless DMX: connection via a lighting console with the optionally available wireless DMX transmitter	x	x
Stand-alone: configuration via a LCD display directly on the housing	x	x

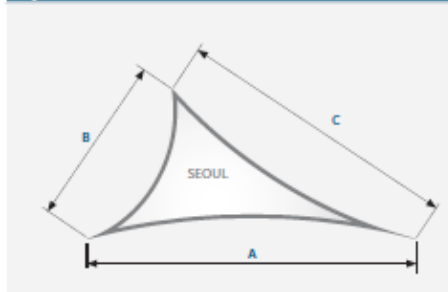

**CATALOGUE 2023 easy sails**

**3-point-sail**

	Size A	Size B	Size C	Weight
SEOUL 1	5.00 m	2.50 m	4.20 m	0.90 kg
SEOUL 2	7.00 m	3.50 m	6.00 m	1.20 kg
SEOUL 3	11.00 m	5.50 m	9.40 m	3.30 kg
SEOUL 4	14.30 m	7.20 m	12.30 m	4.80 kg

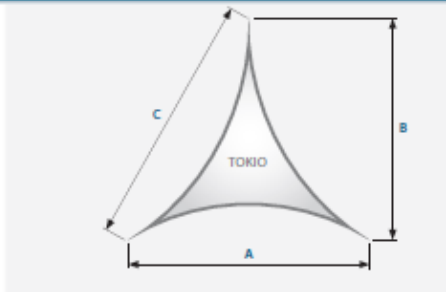

	Size A	Size B	Size C	Weight
TOKIO 1	4.00 m	3.50 m	4.00 m	1.00 kg
TOKIO 2	6.00 m	5.20 m	6.00 m	1.90 kg
TOKIO 3	8.00 m	6.90 m	8.00 m	3.70 kg

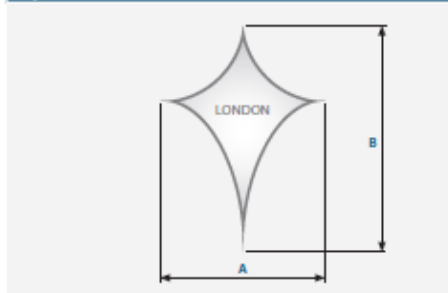
**4-point-sail**

	Size A	Size B	Size C	Weight
LONDON 1	2.20 m	3.00 m	-	0.90 kg
LONDON 2	3.80 m	5.00 m	-	1.50 kg
LONDON 3	5.60 m	7.50 m	-	2.30 kg
LONDON 4	7.50 m	10.00 m	-	4.10 kg

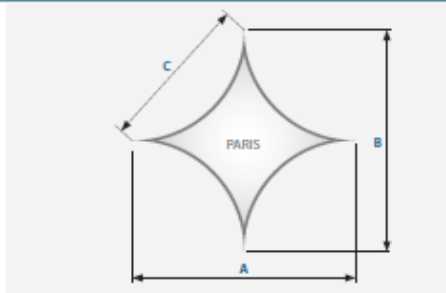

	Size A	Size B	Size C	Weight
PARIS 1	3.00 m	3.00 m	2.10 m	0.80 kg
PARIS 2	5.00 m	5.00 m	3.50 m	1.80 kg
PARIS 3	7.50 m	7.50 m	5.30 m	3.20 kg
PARIS 4	10.00 m	10.00 m	7.10 m	4.40 kg

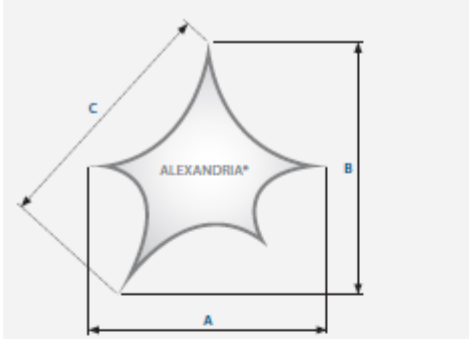
**CATALOGUE 2023 easy sails**
**5-point-sail**

	Size A	Size B	Size C	Weight
ALEXANDRIA 1	7.60 m	8.00 m	8.20 m	3.10 kg
ALEXANDRIA 2	13.00 m	12.50 m	13.50 m	7.90 kg

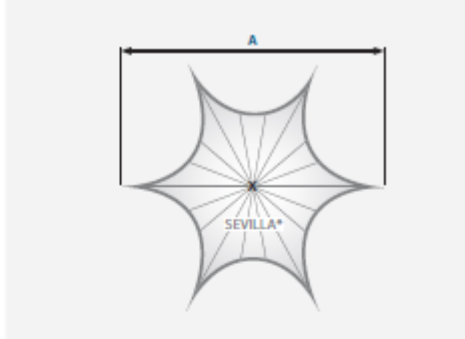
**6-point-sail**

	Size A	Size B	Size C	Weight
SEVILLA 1 <sup>1</sup>	6.50 m	-	-	2.90 kg
SEVILLA 2 <sup>1</sup>	13.00 m	-	-	9.00 kg

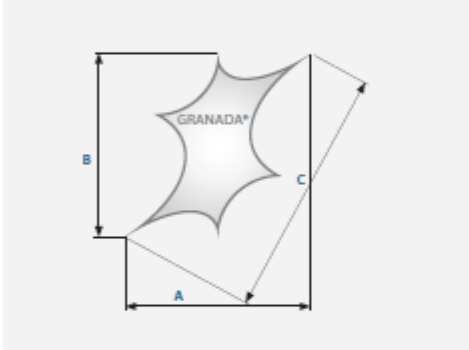
**6-point-sail**

	Size A	Size B	Size C	Weight
GRANADA 1 <sup>2</sup>	7.50 m	7.50 m	10.60 m	3.00 kg
GRANADA 2 <sup>2</sup>	15.00 m	15.00 m	21.20 m	13.50 kg

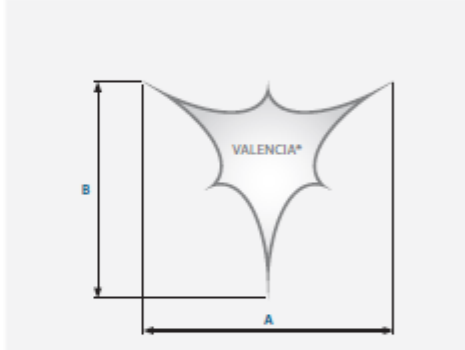

	Size A	Size B	Size C	Weight
VALENCIA 1 <sup>2</sup>	7.50 m	6.50 m	-	3.00 kg
VALENCIA 2 <sup>2</sup>	15.00 m	13.00 m	-	11.70 kg

**General Information**

<sup>1</sup>Sail has one reverse point.

<sup>2</sup>Sail has two reverse points.

- All sails are freely stretched and have no frame. All dimensions refer to the sail when stretched.
- Rental sails are regularly available in white with a grey border. All rental sails are permanently flame retardant in accordance with DIN 4102 B1.
- Purchase sails can be selected using the colour sample card. Custom shapes, custom colours and printed sails upon request.
- You can choose between material which is flame retardant in accordance with DIN 4102 B1, permanently flame retardant in accordance with DIN 4102 B1 or sprinkler suitable (also permanently flame retardant in accordance with DIN 4102 B1).



\* This product is protected as a registered design.





Key to symbols on page B7

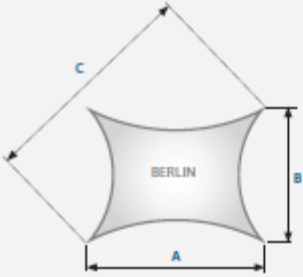

Colours for rent		
White (with grey border)		
Colours for sale		
White	Apple	Gray
Yellow	Turquoise	Anthrax
Orange	Blue 1	Black
Red	Blue 2	Bavarian design
Pink	Cream	Gold
Green	Bordeaux	Silver

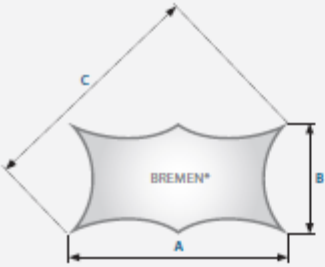
**CATALOGUE 2023 easy sails**

Projection and side wall sail					Projection screen				
									
	Size A	Size B	Size C	Weight		4:3		16:9	
						Width max.	Height max.	Width max.	Height max.
BERLIN 1	3.00 m	2.00 m	3.60 m	1.10 kg	BERLIN 1	1.44 m	1.08 m	1.92 m	1.08 m
BERLIN 2	5.00 m	2.80 m	5.70 m	1.90 kg	BERLIN 2	1.80 m	1.35 m	2.40 m	1.35 m
BERLIN 3	5.00 m	3.80 m	6.30 m	2.30 kg	BERLIN 3	3.02 m	2.27 m	3.30 m	1.85 m

Projection and side wall sail					Projection screen				
									
	Size A	Size B	Size C	Weight		4:3		16:9	
						Width max.	Height max.	Width max.	Height max.
BREMEN	7.50 m	3.80 m	8.40 m	4.80 kg	BREMEN	3.40 m	2.56 m	4.55 m	2.56 m

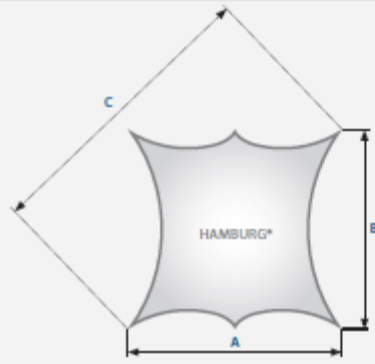
## CATALOGUE 2023 **easy sails**

Projection and side wall sail					Projection screen				
									
	Size A	Size B	Size C	Weight		4:3		16:9	
						Width max.	Height max.	Width max.	Height max.
HAMBURG	7.50 m	7.00 m	10.20 m	5.50 kg	HAMBURG	5.23 m	3.92 m	5.23 m	2.94 m

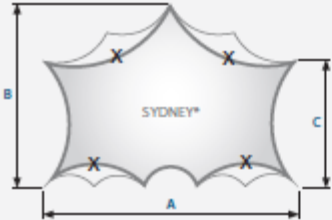
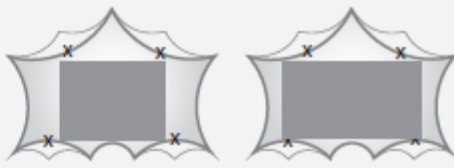
Stage-sail					Projection screen				
 <p>x = possible, additional damping points</p>									
	Size A	Size B	Size C	Weight		4:3		16:9	
						Width max.	Height max.	Width max.	Height max.
SYDNEY 1 <sup>1</sup>	9.00 m	6.50 m	4.50 m	5.70 kg	SYDNEY 1	3.44 m	2.58 m	4.58 m	2.58 m
SYDNEY 2 <sup>1</sup>	13.00 m	10.00 m	6.50 m	14.20 kg	SYDNEY 2	7.33 m	5.50 m	9.63 m	5.40 m

### General Information

<sup>1</sup>Sail has 4 additional stretching points.

- All sails are freely stretched and have no frame. All dimensions refer to the sail when stretched.
- Rental sails are regularly available in white with a grey border. All rental sails are permanently flame retardant in accordance with DIN 4102 B1.
- Purchase sails can be selected using the colour sample card. Custom shapes, custom colours and printed sails upon request.
- You can choose between material which is flame retardant in accordance with DIN 4102 B1, permanently flame retardant in accordance with DIN 4102 B1 or sprinkler suitable (also permanently flame retardant in accordance with DIN 4102 B1).

\*This product is protected as a registered design.



Key to symbols on page 87

Colours for rent		
White (with gray border)		
Colours for sale		
White	Apple	Gray
Yellow	Turquoise	Anthracte
Orange	Blue 1	Black
Red	Blue 2	Bavarian design
Pink	Cream	Gold
Green	Bordeaux	Silver



## CATALOGUE 2023 **easy sails**

### easy sails

Prix :	<u>Location (blanc) :</u>	<u>Vente :</u>
SEOUL 1 :	CHF 140. --	CHF 240. --
SEOUL 2 :	CHF 230. --	CHF 390. --
SEOUL 3 :	CHF 380. --	CHF 660. --
SEOUL 4 :	CHF 490. --	CHF 830. --
TOKIO 1 :	CHF 140. --	CHF 240. --
TOKIO 2 :	CHF 230. --	CHF 390. --
TOKIO 3 :	CHF 330. --	CHF 580. --
LONDON 1 :	CHF 110. --	CHF 190. --
LONDON 2 :	CHF 180. --	CHF 310. --
LONDON 3 :	CHF 300. --	CHF 320. --
LONDON 4 :	CHF 440. --	CHF 760. --
PARIS 1 :	CHF 110. --	CHF 190. --
PARIS 2 :	CHF 230. --	CHF 390. --
PARIS 3 :	CHF 320. --	CHF 550. --
PARIS 4 :	CHF 530. --	CHF 910. --
ALEXANDRIA 1 :	CHF 430. --	CHF 730. --
ALEXANDRIA 2 :	CHF 690. --	CHF 1190. --
SEVILLA 1 :	CHF 380. --	CHF 690. --
SEVILLA 2 :	CHF 1060. --	CHF 1820. --
GRANADA 1 :	CHF 370. --	CHF 620. --
GRANADA 2 :	CHF 990. --	CHF 1690. --
VALENCIA 1 :	CHF 390. --	CHF 680. --
VALENCIA 2 :	CHF 740. --	CHF 1280. --
BERLIN 1 :	CHF 110. --	CHF 190. --
BERLIN 2 :	CHF 195. --	CHF 350. --
BERLIN 3 :	CHF 230. --	CHF 390. --
BREMEN :	CHF 320. --	CHF 550. --
HAMBOURG :	CHF 430. --	CHF 730. --
SYDNEY 1 :	CHF 590. --	CHF 1020. --
SYDNEY 2 :	CHF 1070. --	CHF 1820. --

#### Fabrication :

80%Polyamide, 20% Elasthanne  
 Anneaux et crochets de fixation  
 Trou au centre avec fixations en textile  
 Norme anti-feu : DIN 4102 B1

## CATALOGUE 2023 easy sky & truss covers



### easy sky



4-Corner Pagoda

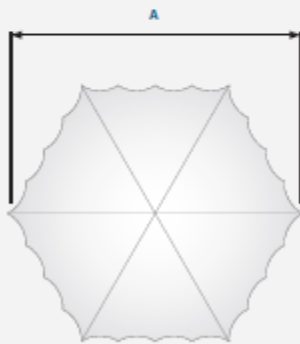

6-Corner and/or  
Multiple Corner Pavilion

- Up to 50% less expensive than standard interior skies for pagoda and pavilion tents with a large colour selection features six colours for rent.

- Time-saving installation, since the **easy stretch** sky can be installed by a single person in just a few minutes. The plastic hooks built into the eyelets can be easily suspended in the profile groove.

- Suitable for all four-sided pagoda tents from 3.0 – 10.0 m and multi-corner pavilions from 6.0 – 10.0 m.

- An opening exists in each easy sky so that a lighting unit can easily be installed.

- The **easy stretch** material is a stretchable fibre made from polyamide and elastane which is flame retardant in accordance with DIN 4102 B1. The technical fibre is resistant, easy to care for and does not need to be smoothed before installation.

	Size A	Weight
4-Corner Pagoda	3.00 m	1.90 kg
4-Corner Pagoda	4.00 m	2.80 kg
4-Corner Pagoda	5.00 m	4.10 kg
4-Corner Pagoda	6.00 m	6.30 kg
4-Corner Pagoda	8.00 m	10.00 kg
4-Corner Pagoda	10.00 m	16.20 kg
6-Corner and/or Multiple Corner Pavilion	6.00 m	3.70 kg
6-Corner and/or Multiple Corner Pavilion	8.00 m	6.50 kg
6-Corner and/or Multiple Corner Pavilion	10.00 m	10.40 kg

#### Colours for rent

White (with grey border)	Red
Yellow	Blue 2
Orange	Green

#### Colours for sale

White	Apple	Gray
Yellow	Turquoise	Anthraxite
Orange	Blue 1	Black
Red	Blue 2	Bavarian design
Pink	Cream	Gold
Green	Bordeaux	Silver

## CATALOGUE 2023 **easy sky & truss covers**

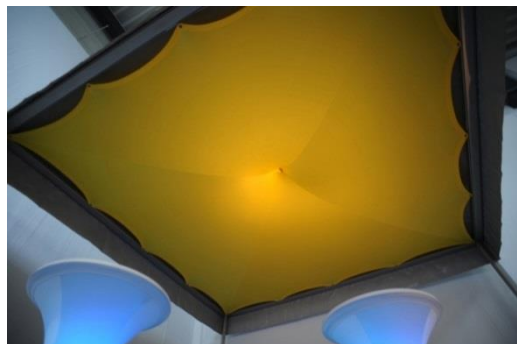

### easy sky

Prix :

easy sky 3x3m :  
 easy sky 4x4m :  
 easy sky 5x5m :  
 easy sky 6x6m :  
 easy sky 8x8m :  
 easy sky 10x10m :

Location (blanc) :

CHF 90. --  
 CHF 120. --  
 CHF 150. --  
 CHF 190. --  
 CHF 220. --  
 CHF 290. --

Vente :

CHF 430. --  
 CHF 490. --  
 CHF 590. --  
 CHF 790. --  
 CHF 1090. --  
 CHF 1590. --

easy sky hexagonal 6m :  
 easy sky hexagonal 8m :  
 easy sky hexagonal 10m :

CHF 180. --  
 CHF 220. --  
 CHF 280. --

CHF 650. --  
 CHF 990. --  
 CHF 1390. --

+ Forfait de livraison

Fabrication :

80%Polyamide, 20% Elasthanne  
 Anneaux et crochets de fixation  
 Trou au centre avec fixations en textile  
 Norme anti-feu : DIN 4102 B1



### TRUSS COVER

Prix sur demande



**CATALOGUE 2023 easy cover****SELARIA & DINERIA****Housse de chaise SELERIA**

Housse en tissu stretch heavy non-feu M1

Prix : CHF 8.50

**Ruban SELERIA**

Prix : CHF 2.50

**Rubans SELERIA****Housse SELERIA avec 1 ruban**

Prix : CHF 11. --



## CATALOGUE 2023 **easy cover**

### SELARIA & DINERIA



#### Housse SELERIA avec 2 rubans

Prix : CHF 13. --



#### Table haute Galactica

Textile stretch blanc ou noir non-feu

Dimensions : H 110 / Ø 80cm

Housse de plateau avec plexi de protection sous la housse

Protection des pieds

Table + housse et protections : CHF 95.-- pièce

Housses de tables hautes d'autres coloris disponibles sur demande

Option éclairage à LED : CHF 30.--



#### DINERIA

Housse de table

Diamètre 120cm - Prix : CHF 40. --

Diamètre 150cm - Prix : CHF 45. --

Diamètre 180cm - Prix : CHF 50. --

Protections de plateau inclus (Top Cover)



#### CONFERIA

Housse de table

Divers coloris et formats

Prix sur demande

## CATALOGUE 2023 **innolution systems**

### WALLsystem



#### WALL 2D

WALL 2D Hauteur 2m :

LA 0.5m : CHF 30. --  
 LA 1m : CHF 45. --  
 LA 1.50m : CHF 55. --  
 LA 2m : CHF 65. --

WALL 2D Hauteur 2.50m :

LA 0.5m : CHF 45. --  
 LA 1m : CHF 55. --  
 LA 1.5m : CHF 70. --  
 LA 2m : CHF 80. --

Jeu de pieds : CHF 20. --

Couleur de tissu stretch disponible en location :  
 Blanc, rouge, bleu, gris et noir

Eclairage et branding sur demande  
 Disponible également à la vente

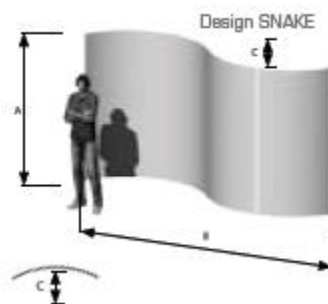
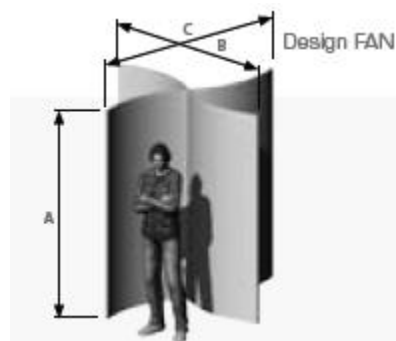

CURVED WALL  
 Element A1



CURVED WALL  
 Element A2



CURVED WALL :

Elément A1 : HA 2m – LA 1m : CHF 50. --  
 Elément A1 : HA 2.50m – LA 1m : CHF 55. --  
 Elément A2 : HA 2m – LA 1.40m : CHF 60. --  
 Elément A2 : HA 2.50m – LA 1.40m : CHF 70. --  
 Design SNAKE : HA 2m – LA 2.80m : CHF 120. --  
 Design SNAKE : HA 2.50m – LA 2.80m : CHF 130. --  
 Design FAN : HA 2m – LA 2m : CHF 170. --  
 Design FAN : HA 2.50m – LA 2m : CHF 190. --  
 Pied : CHF 10. --

Couleur de tissu stretch disponible en location :  
 Blanc, rouge, bleu, jaune, noir, gris, crème et bordeaux

Eclairage et branding sur demande  
 Disponible également à la vente



## CATALOGUE 2023 **innolution systems**

### WALLsystem



#### WALL 3D

WALL 3D Hauteur 2m :

LA 0.5m : CHF 75. --  
LA 1m : CHF 95. --  
LA 1.50m : CHF 120. --  
LA 2m : CHF 150. --

WALL 3D Hauteur 2.50m :

LA 0.5m : CHF 80. --  
LA 1m : CHF 120. --  
LA 1.5m : CHF 150. --  
LA 2m : CHF 170. --

Couleur de tissu stretch disponible en location :  
Blanc, rouge, bleu, jaune., noir, gris, crème et bordeaux

Eclairage et branding sur demande  
Disponible également à la vente



#### DESIGN EASY WALL 3D

HA 2m – LA 2m – PR 0.50m : CHF 150.--  
HA 2m – LA 2.50m – PR 0.50m : CHF 180.--  
HA 2.50m – LA 2m – PR 0.50m : CHF 180.--

Lestage : 12. --

Couleur de tissu stretch disponible en location :  
Blanc, rouge, bleu, jaune., noir, gris, crème et bordeaux

Eclairage et branding sur demande  
Disponible également à la vente

## CATALOGUE 2023 **innolution systems**

### COLUMNsystem



#### SQUARE COLUMN

SQUARE COLUMN Hauteur 2m :

LA 0.5m : CHF 75. --

LA 1m : CHF 120. --

LA 1.50m : CHF 145. --

SQUARE COLUMN Hauteur 2.50m :

LA 0.5m : CHF 90. --

LA 1m : CHF 130. --

LA 1.50m : CHF 160. --

Lestage : CHF 10. --

Couleur de tissu stretch disponible en location :

Blanc, rouge, bleu, jaune,, noir, gris, crème et bordeaux

Eclairage et branding sur demande

Disponible également à la vente

### WAVE



#### WAVE

WAVE : HA 3.00m – LA au sol 5.50m – PR 2.00m

Prix :

Blanc : CHF 750. –

Eclairage et branding sur demande

Disponible également à la vente





## CATALOGUE 2023 **innolution systems**

### DINNER & COCKTAIL



### STAND & VISUAL

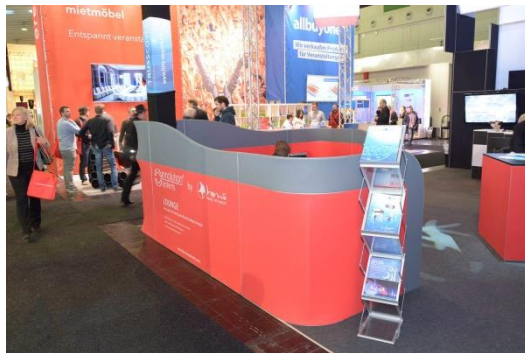

## CATALOGUE 2023 **innolution systems**

### WALLsystem WALL 2D

Simple and functional: With the modular prefabricated construction system, standard heights of 2.0 m and 2.5 m can be created. The standard modules are available in lengths of 0.5 m; 1.0 m; 1.5 m and 2.0 m. WALL 2D can be joined together without a gap or set up individually.

- Can be covered on both sides with stretch fabric
- Seamless look
- Free-standing design possible with feet
- Versatile e.g. as a presentation wall, room divider or printed advertising display
- Generation of any desired length of wall displays – straight or around the corner
- Large prints can be stretched over several frames without a gap

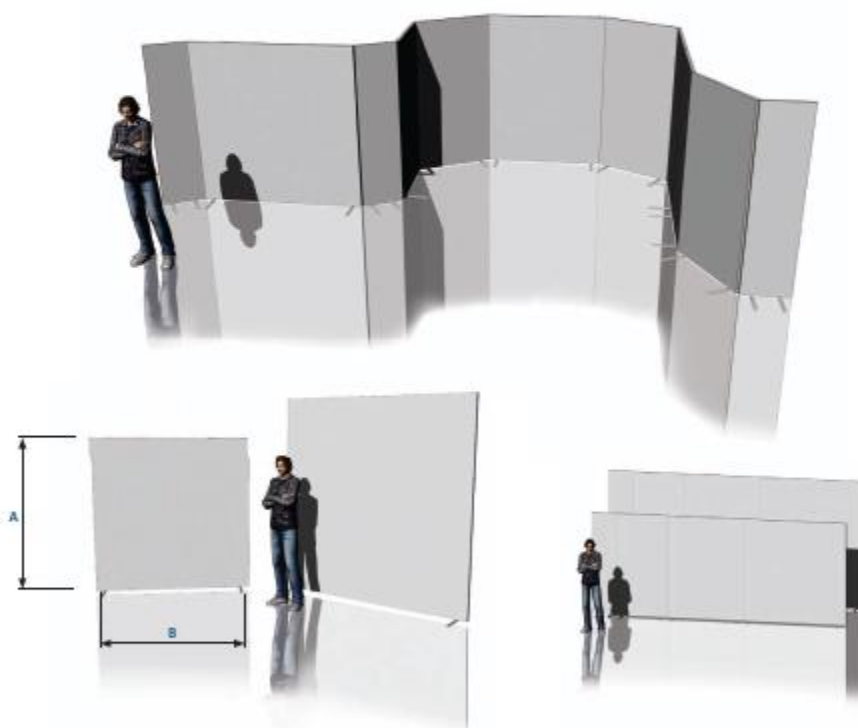

	size A - standard heights	size B - modular standard lengths	comment
WALL 2D	2,0 m/ 2,5 m	0,5 m/ 1,0 m/ 1,5 m/ 2,0 m	special sizes at purchase are available upon request.
stretch fabric colours for rent			
stretch fabric colours for sale			

Price, availability and delivery time of other colours upon request. All colours are permanently flame retardant according to DIN 4102 B1.

## CATALOGUE 2023 **easy air system**

### WALLsystem CURVED WALL

The elegant, curved designs make CURVED WALL a real eye-catcher. Through the different angle sizes, bigger or smaller curved walls can be created. Depending on the arrangement of the modules, any desired shape can be created. CURVED WALL can be freely combined with WALL 2D resulting in more combination possibilities.

- Elegant, curved shape
- Gapless modular or individual piece construction possible
- Seamless look
- Can be covered on both sides with stretch fabric
- Individual motif print possible

CURVED WALL element A1



Design FAN





CURVED WALL element A2



Design SNAKE



 innovation systems	size A - standard heights	size B	size C - maximum depth	comment
Design SNAKE	2,0 m/ 2,5 m	2,8 m	0,5 m	special sizes at purchase are available upon request
Design FAN	2,0 m/ 2,5 m	2,0 m	2,0 m	
CURVED WALL element A1	2,0 m/ 2,5 m	1,0 m	0,15 m	
CURVED WALL element A2	2,0 m/ 2,5 m	1,4 m	0,25 m	
stretch fabric colours for rent				
stretch fabric colours for sale				

Price, availability and delivery time of other colours upon request. All colours are permanently flame retardant according to DIN 4102 B1.



## CATALOGUE 2023 **innolution systems**

### WALLsystem WALL 3D

The proven WALLsystem is also available as a three-dimensional piece. The standard depth in the free-standing wall design is 0.5 m which means LED lighting can be easily integrated. WALL 3D is available in heights of 2.0 m und 2.5 m and standard lengths of 0.5 m; 1.0 m; 1.5 m; 2.0 m. The separate WALLsystem 3D elements can be placed on top of each other and do not require connectors.

- Can be covered with stretch fabric all around
- Self-standing design possible with 0.5 m standard depth
- Generation of any desired length of wall displays – straight or around the corner
- Versatile e.g. as presentation wall, room divider or luminary
- Use as advertising display through large-area printing



	size A - standard heights	size B - modular standard lengths	size C - max. depth	comment
WALL 3D	2,0 m/ 2,5 m	0,5 m/ 1,0 m/ 1,5 m/ 2,0 m	0,5 m	special sizes at purchase are available upon request.
stretch fabric colours for rent				
stretch fabric colours for sale				

Price, availability and delivery time of other colours upon request. Additional ballasting of WALL 3D possible. All colours are permanently flame retardant according to DIN 4102 B1.



## CATALOGUE 2023 **easy air system**

### WALLsystem CURVED WALL 3D

Design areas and create new spaces. As a three-dimensional piece, CURVED WALL 3D can be used as desired and in the heights 2.0 m and 2.5 m. The standard depth of the self-standing wall design is 0.5 m meaning LED lighting can be easily integrated.

- Attractive design through its curved shapes
- Can be used separately or in combination
- Seamless look
- Versatile e.g. as presentation wall, room divider or luminary
- Large-area printing possible

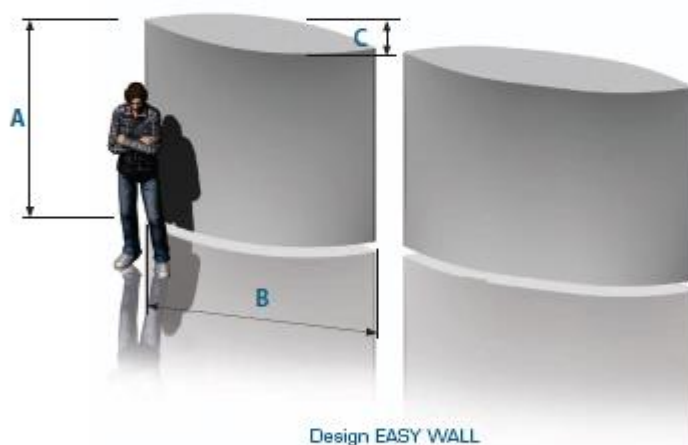

	size A - height	size B - length	size C - max. depth	comment
Design EASY WALL	2,0 m	2,0 m/ 2,5 m	0,5 m	special sizes at purchase are available upon request
stretch fabric colours for rent				
stretch fabric colours for sale				

Price, availability and delivery time of other colours upon request. Additional ballasting of CURVED WALL 3D possible. All colours are permanently flame retardant according to DIN 4102 B1.



## CATALOGUE 2023 **innolution systems**

### COLUMNsystem SQUARE COLUMN

Set accents – round space sculptures which are self-standing or can be placed freely suspended in the room. COLUMNsystem is especially effective if it is lighted from within. With a printed cover, COLUMNsystem can be used as 360° advertising column.

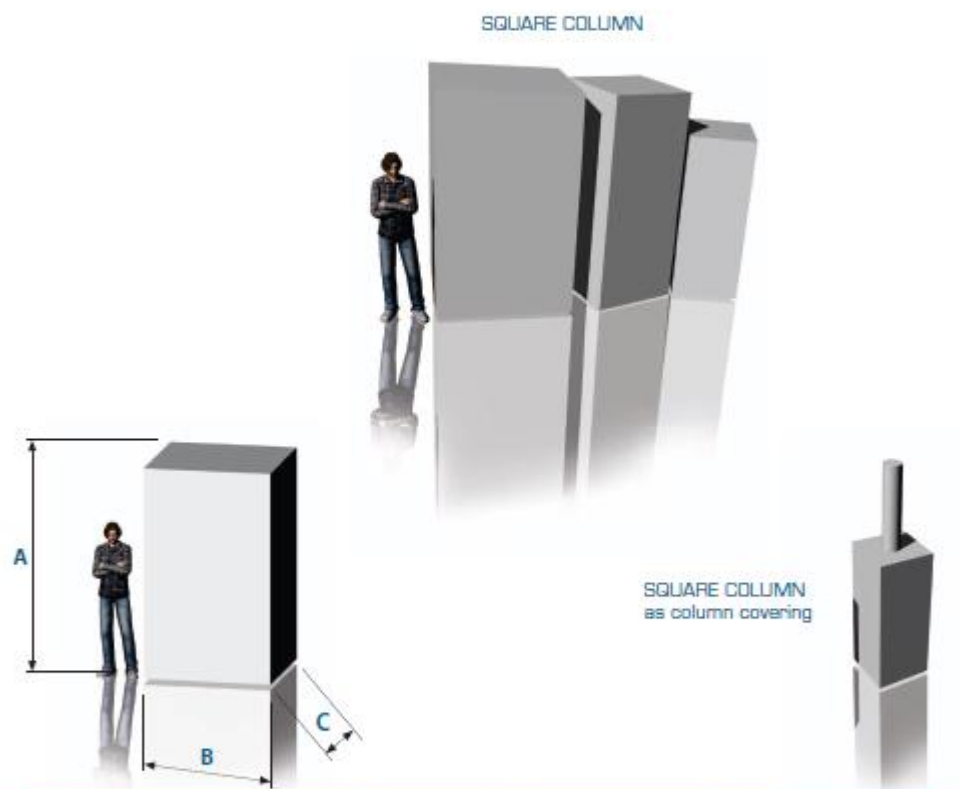
- Self-standing or can be suspended
- Round shape in two possible heights
- Large-area 360° printing possible
- Can be ideally used as advertising medium or luminary



 Innolution systems	size A - height	size B - length	size C - depth	comment
SQUARE COLUMN	2,0 m / 2,5 m	0,5 m	0,5 m	special sizes at purchase are available upon request
SQUARE COLUMN	2,0 m / 2,5 m	1,0 m	1,0 m	
SQUARE COLUMN	2,0 m / 2,5 m	1,5 m	1,5 m	
stretch fabric colours for rent				
stretch fabric colours for sale				

Price, availability and delivery time of other colours upon request. As a self-standing element Column system must also be ballasted. All colours are permanently flame retardant according to DIN 4102 B1.



Liste de prix de location 2023 indicative et non-contractuelle, hors-livraison et hors TVA.  
Pour plus de détails, veuillez consulter nos conditions générales de location.

*L'ensemble des produits est également disponible à la vente.*

© 2007-2023 Luminance Sàrl. Tous droits réservés.